

LEVEL 3
ELEV. 1092'-0"

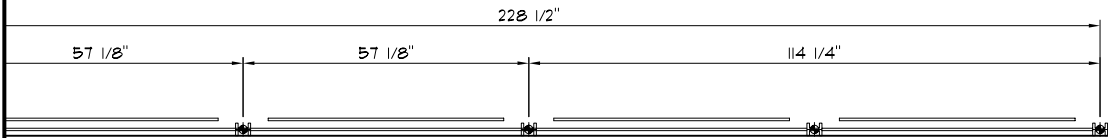

POINT SUPPORTED GLASS HANDRAIL ELEVATION

SCALE: 1/8" = 1'-0"

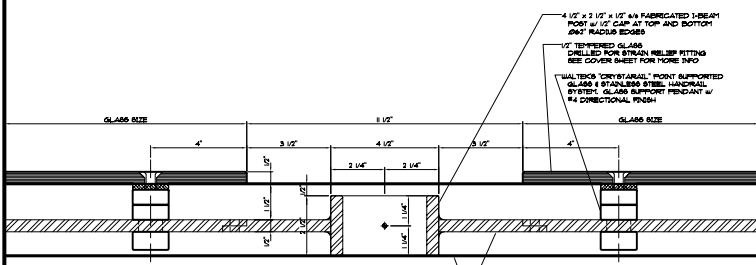

INTERMEDIATE DETAIL

SCALE: 1 1/2" = 1'-0"

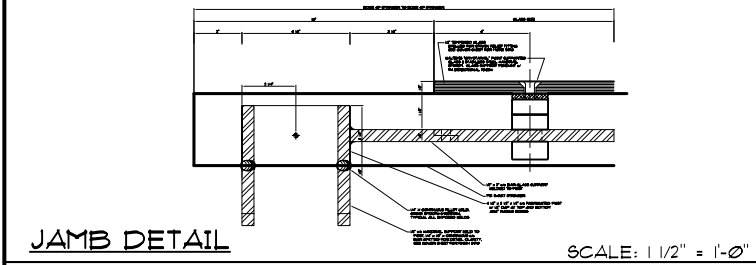

JAMB DETAIL

SCALE: 1 1/2" = 1'-0"

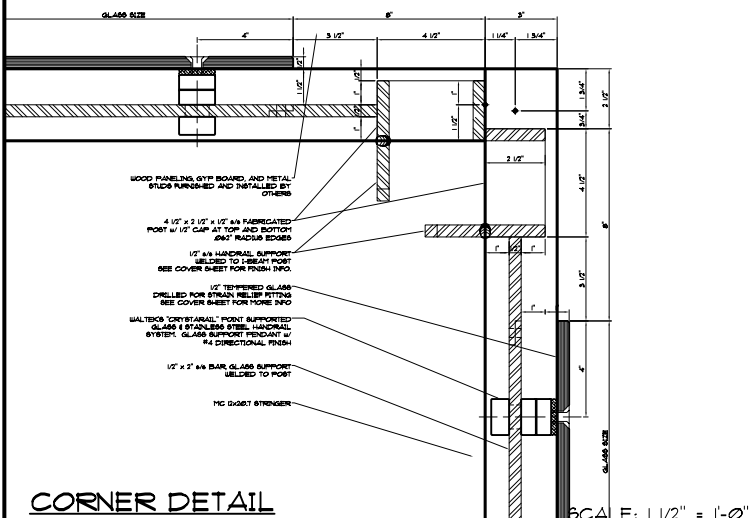

CORNER DETAIL

SCALE: 1 1/2" = 1'-0"

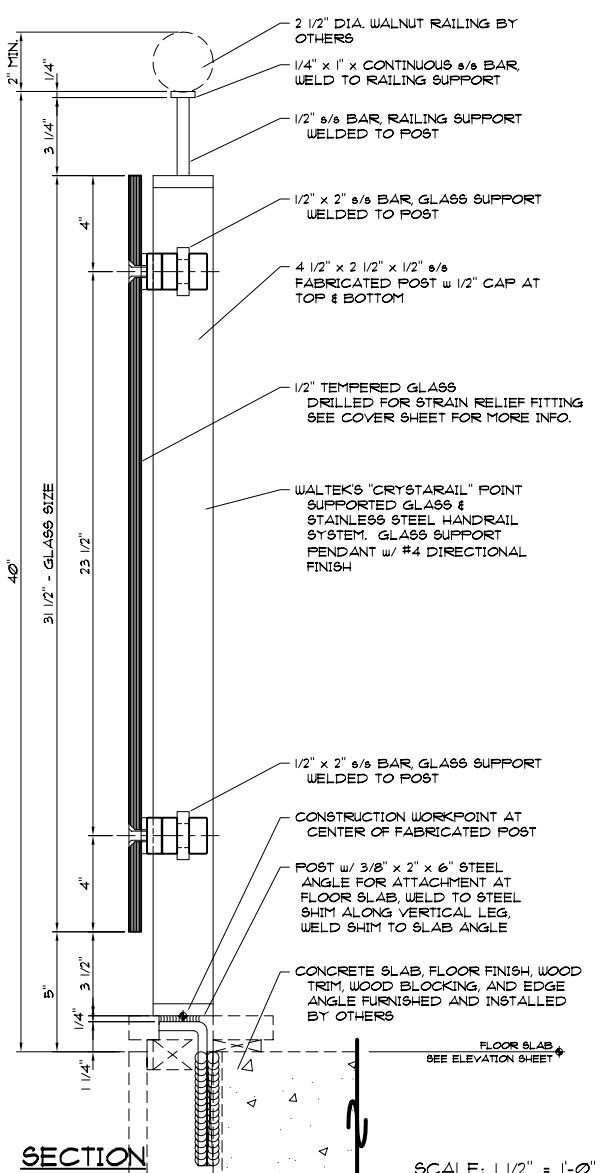

SECTION

SCALE: 1 1/2" = 1'-0"

VISIT US ON THE WEB AT: WWW.WALTEKLTD.COM - OR E-MAIL US AT SALES@WALTEKLTD.COM

CINCINNATI: (513) 577-7980

NASHVILLE: (615) 251-7040



IF YOU WOULD LIKE TO LEARN MORE ABOUT OUR WALL SYSTEMS OR WISH TO DISCUSS PROJECT SPECIFIC DETAILS PLEASE CONTACT US AT THE ADDRESS & PHONE NUMBER SHOWN.

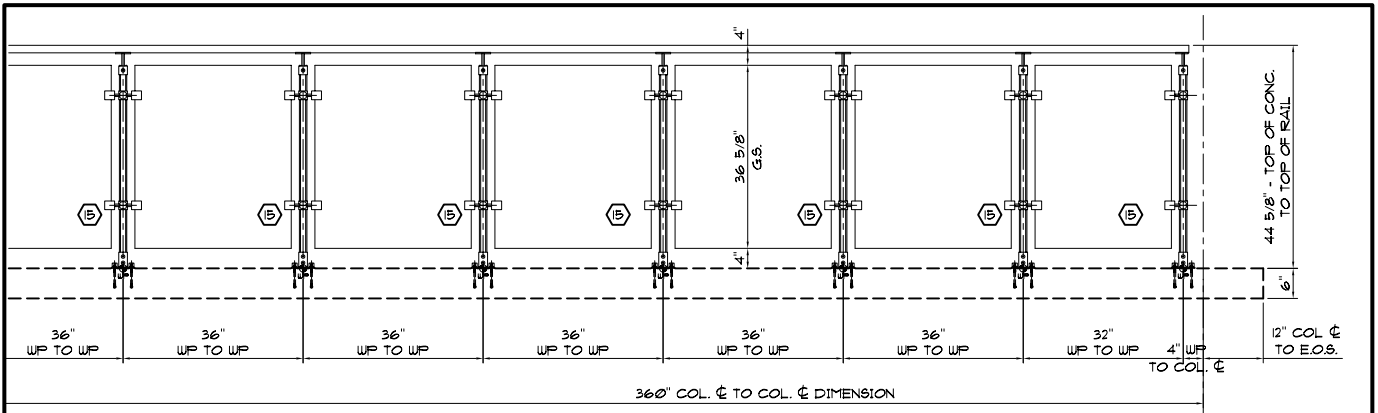

POINT SUPPORTED GLASS HANDRAIL ELEVATION

SCALE: 1/8" = 1'-0"

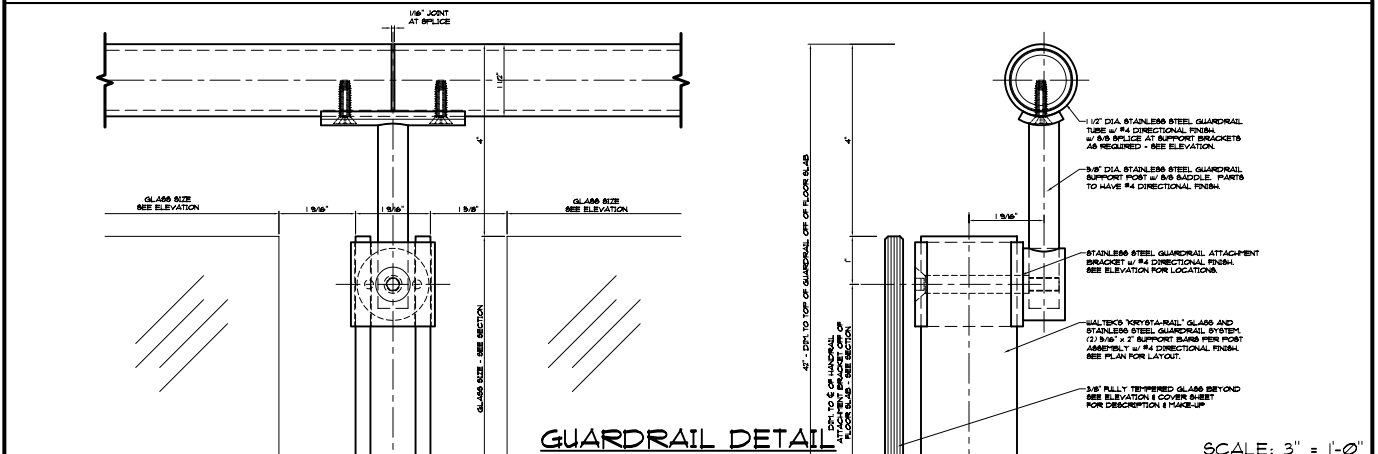

GUARDRAIL DETAIL

SCALE: 3" = 1'-0"

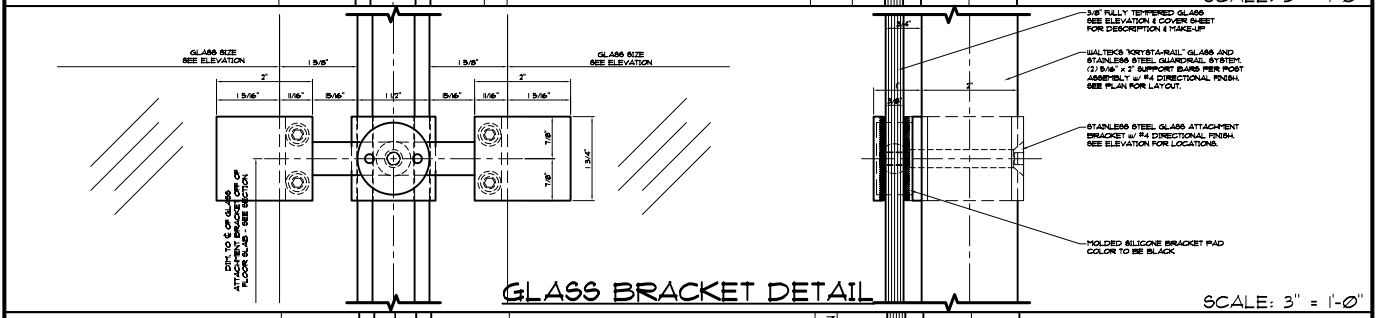

GLASS BRACKET DETAIL

SCALE: 3" = 1'-0"

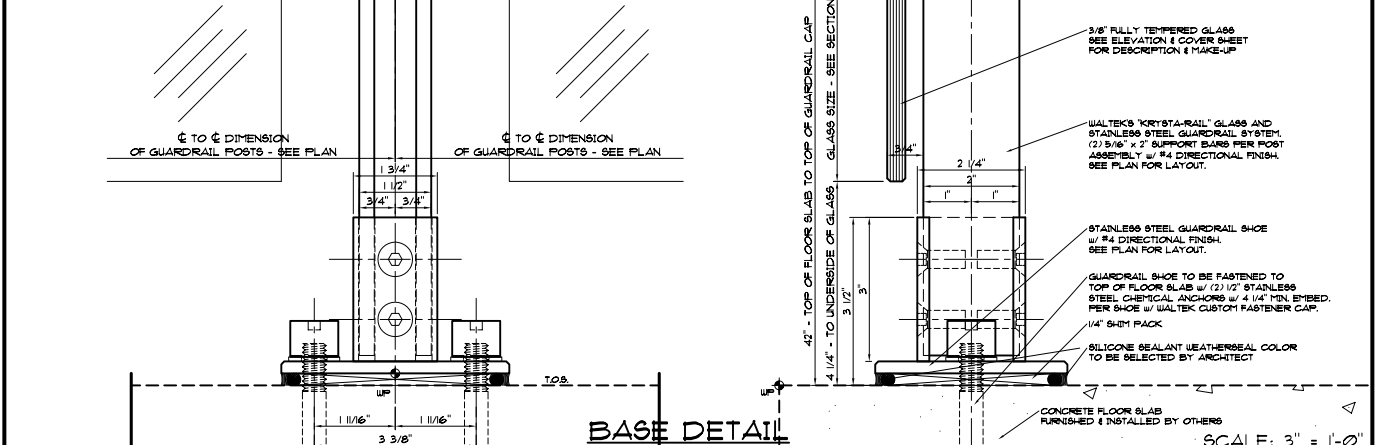

BASE DETAIL

SCALE: 3" = 1'-0"

VISIT US ON THE WEB AT: WWW.WALTEKLTD.COM - OR E-MAIL US AT SALES@WALTEKLTD.COM

CINCINNATI: (513) 577-7980

NASHVILLE: (615) 251-7040



IF YOU WOULD LIKE TO LEARN MORE ABOUT OUR WALL SYSTEMS OR WISH TO DISCUSS PROJECT SPECIFIC DETAILS PLEASE CONTACT US AT THE ADDRESS & PHONE NUMBER SHOWN.